

# nsc 03 assembly

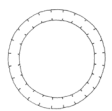

24 x petals  
(+ 2 spare)



2 x rings



1 x hanger

1

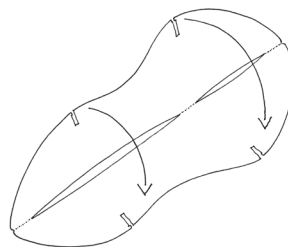

It's best to start with clean, dry hands. Carefully fold the petals in half along the perforated line.

2

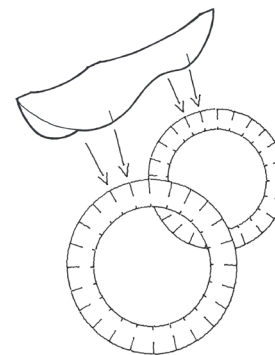

Fit each petal first to one ring, then the other, as shown above. This can be fiddly at first, but the more patient you are the better the result.

3

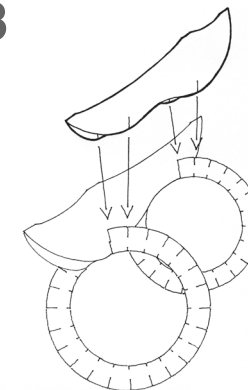

Work your way around the rings, slotting in the petals. Make sure each petal overlaps with the previous one by sharing the slots in the rings, as shown above.

4

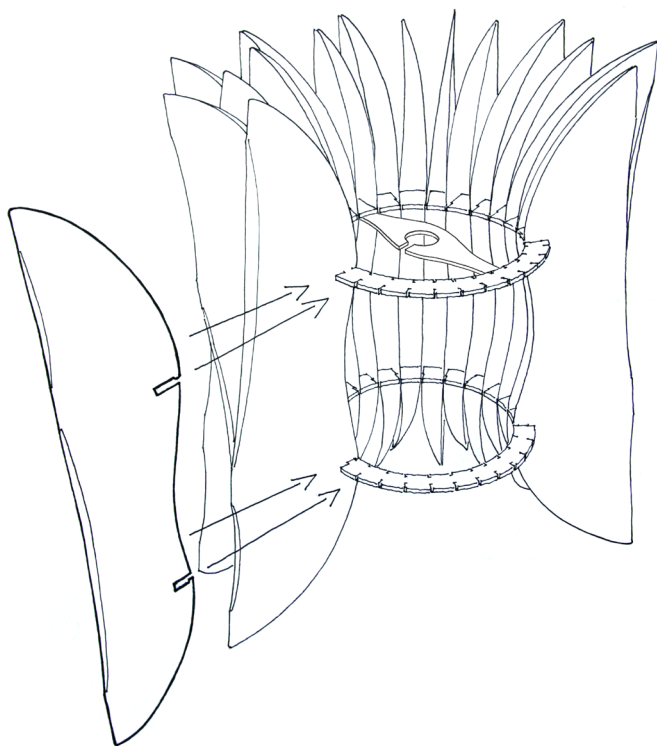

After you have fitted about two thirds of the petals, you may find it easier to turn the shade into an upright position to fit the remaining petals. Once all the petals are in place, insert the hanger into the top ring, as shown. Make sure the hanger spans across the centre of the ring, not to one side or the other.

5

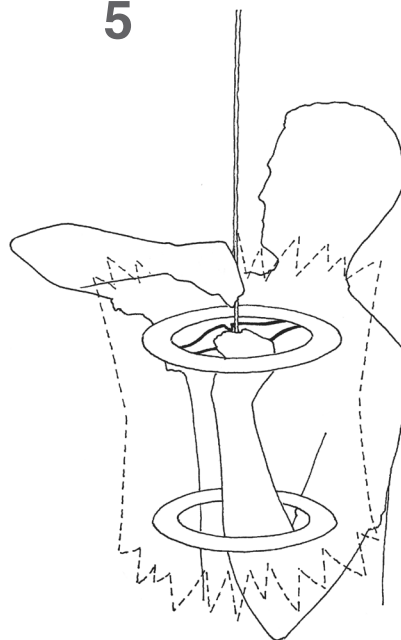

Lift the shade by holding the hanger from underneath, as shown, and use your other hand to engage the light cord from above.

6

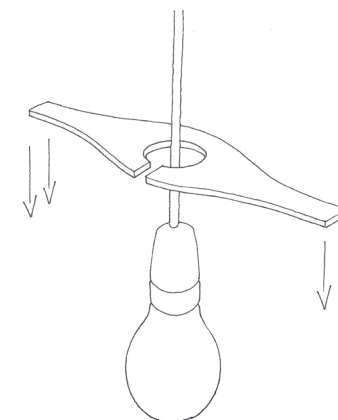

Fit the cord into the eye in the hanger, as shown.

**CAUTION: the bulb should hang centrally within the shade WITHOUT touching the paper fins. Failure to ensure this may result in damage to the shade and even combustion**